



比亚迪
半导体

BOS-0603WDW

PRODUCT SPECIFICATION

Model No: BOS-0603WDW

For reference only.

Subject to change maybe necessary in a limited number of cases

Descriptions:

- **Miniature Surface Mounted Chip LED**
- **Upward-lightning And Surface Mounted Type (PLCC-2 Package)**
- **Emitting Color : White**
- **Viewing Angle : 120°**



CUSTOMER APPROVED SIGNATURES	APPROVED BY	CHECKED BY	PREPARED BY
	Zheng.maoling	Lin.yankai	Liao.bin

Address: Xiangshui River, Economic

地址: 广东省惠州市大亚湾响水河 (516083)

Development Zone, Daya Bay, Huizhou,
Guangdong, 516083 P.R. China

电话: +86-755-89888888; +86-752-5118888

http: // www.byd.com.cn



■ Applications

- Mobile Phone
- Back_light
- Automotive Interior Lighting

...

■ Device Selection Guide

Model No.	Chip		Epoxy Color
	Material	Emitting Color	
BOS-0603WDW	InGaN	White	Yellow Diffused

■ Package Outline Dimensions

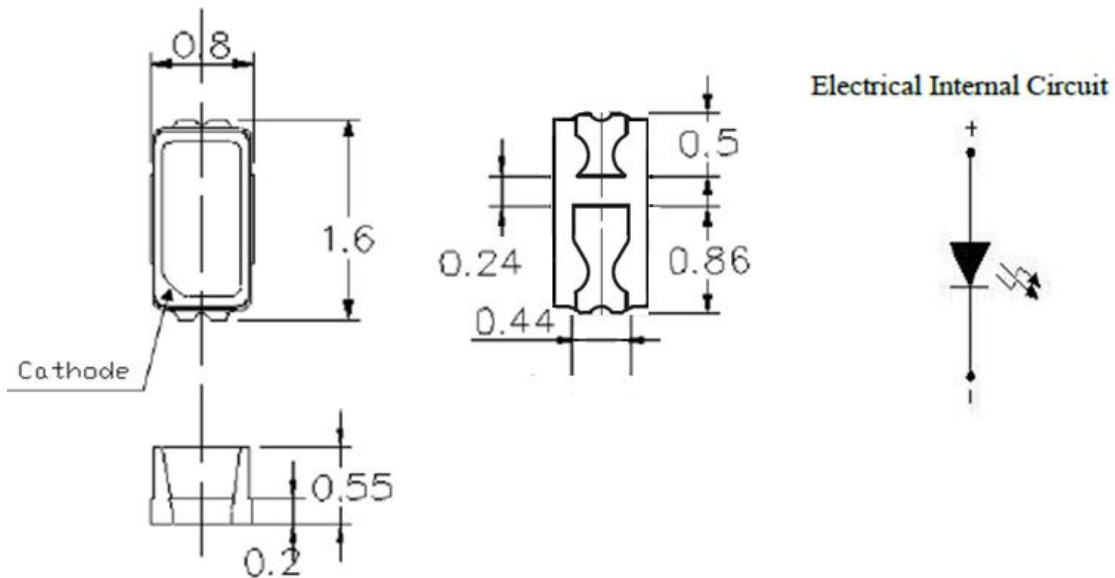

Recommended Soldering Pad

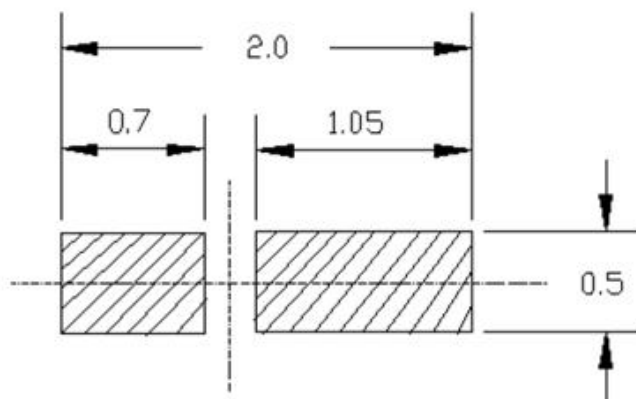

Notes:

All dimensions in mm

tolerance ± 0.1 mm

unless otherwise noted



■ Absolute Maximum Ratings(Ta=25° C)

Items	Symbol	Absolute Maximum Ratings	Unit
Power Dissipation	P _d	70	mW
Forward Current(DC)	I _F	20	mA
Peak Forward Current*	I _{FP}	100	mA
Reverse Voltage	V _R	5	V
Junction Temperature	T _J	125	°C
Operation Temperature	T _{opr}	-40 ~ +110	°C
Storage Temperature	T _{stg}	-40 ~ +110	°C
Electrostatic Discharge	ESD	2000	V
Lead Soldering Temperature	T _{sol}	260°C for 5 Seconds	

*Pulse Width \leq 0.1msec and Duty \leq 1/10

■ Typical Electrical & Optical Characteristics (Ta=25°C)

Items	Symbol	Condition	Min.	Typ.	Max.	Unit
Forward Voltage	V _F	I _F =5mA	2.7	2.9	3.1	V
Reverse Current	I _R	V _R =5V	---	---	10	μA
Luminous Intensity	I _v	I _F =5mA	---	480	---	mcd
50% Power Angle	2θ _{1/2}	I _F =5mA	---	120	---	deg

■ Forward Voltage Rank Limits (I_F =5mA)

Code	Min	Max	Unit
L	2.7	2.8	V
M	2.8	2.9	
N	2.9	3.0	
O	3.0	3.1	

■ Luminous Intensity Rank Limits(I_F =5mA)

Code	Min	Max	Unit
K	380	450	mcd
L	450	520	
M	520	600	



■ Chromaticity Coordinate Rank Limits(IF =5mA)

Rank	Measure conditions: IF=5mA							
	(x1,y1)		(x2,y2)		(x3,y3)		(x4,y4)	
	x1	y1	x 2	y2	X3	y 3	X4	y 4
D	0.2500	0.2300	0.2900	0.2300	0.3050	0.2600	0.2600	0.2600
E	0.2600	0.2600	0.3050	0.2600	0.3200	0.2900	0.2750	0.2900
F	0.2750	0.2900	0.3200	0.2900	0.3350	0.3200	0.2950	0.3200
G	0.2950	0.3200	0.3350	0.3200	0.3500	0.3500	0.3100	0.3500

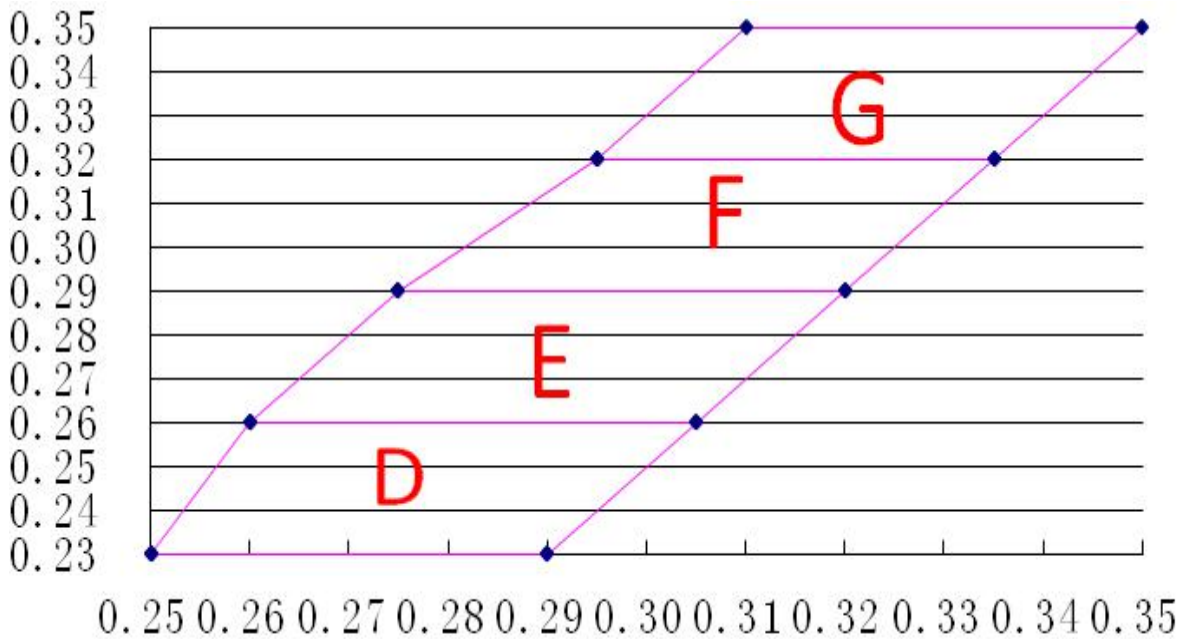

- Notes: 1. Tolerance of measurement of forward voltage is $\pm 0.05V$;
 2. Tolerance of measurement of luminous intensity is $\pm 10\%$;

Note: For long-term performance, the drive currents between 1 mA and 20 mA are recommended. If the drive currents is different with our condition ,Please contact our customer service.

■ Typical Electrical / Optical Characteristics Curves
($T_a = 25^\circ\text{C}$ Unless Otherwise Noted)

Fig.1 Forward Current vs. Forward Voltage

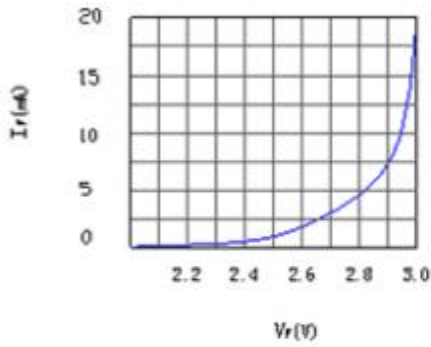

Fig.2 Relative Luminous Intensity vs. Forward Current

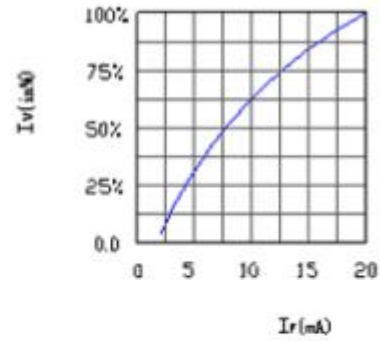

Fig.3 Relative Luminous Intensity vs. Wavelength

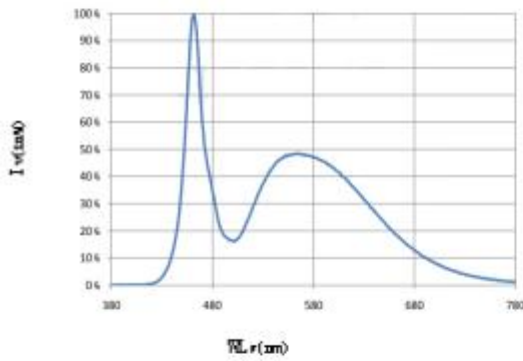

Fig.4 Relative Luminous Intensity vs. Ambient Temperature

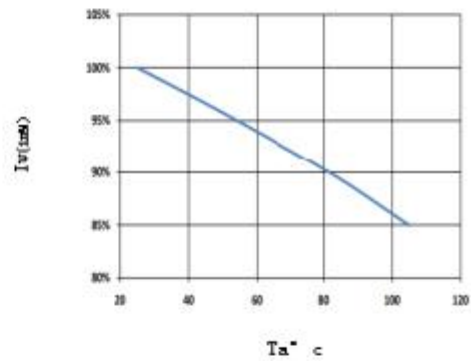

Fig.5 Maximum Forward Current vs. Ambient Temperature

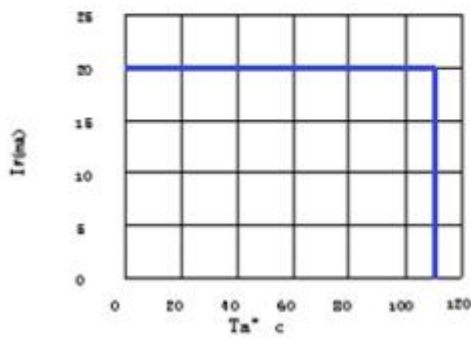
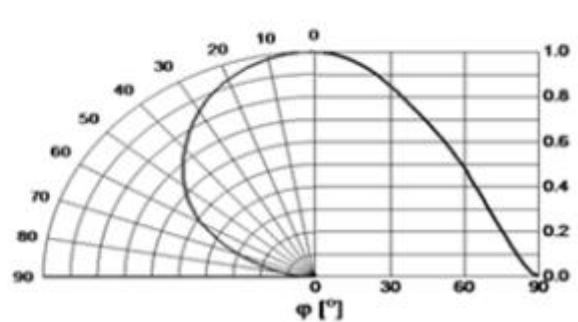

Fig.6 Relative Luminous Intensity vs. Radiation Angle





■ Packing Specification

1. Packing Type: Reel and Anti-electrostatic Bag
2. Packing Standard Quantity: 4000pcs/Reel, 40kpcs/box.
Note: The same Rank LED should be in the same box.

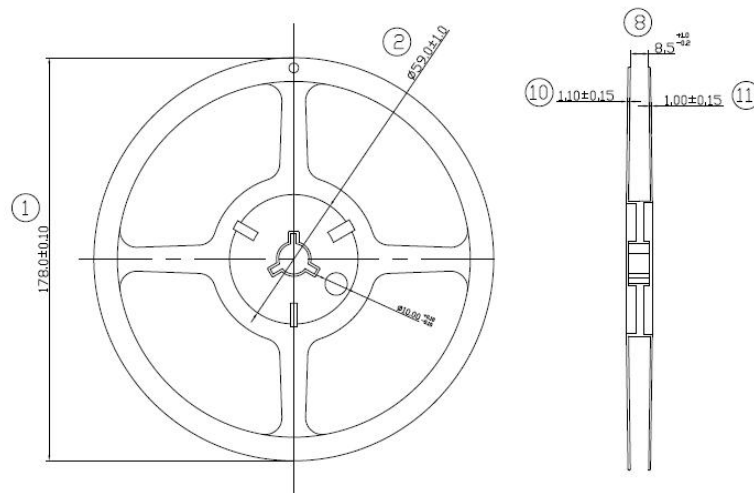
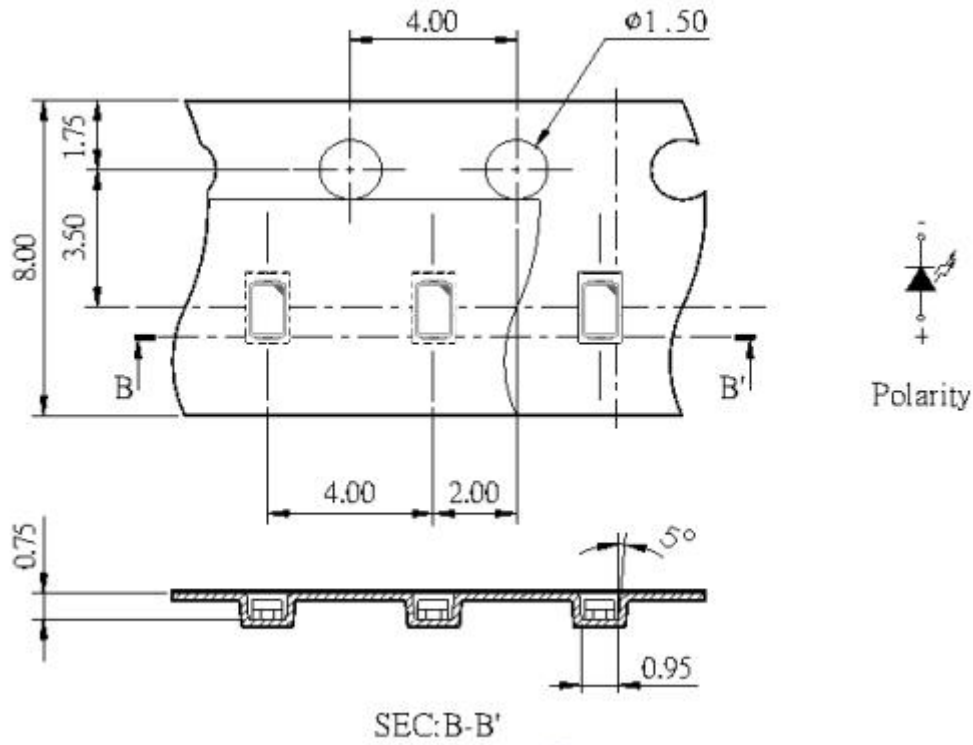

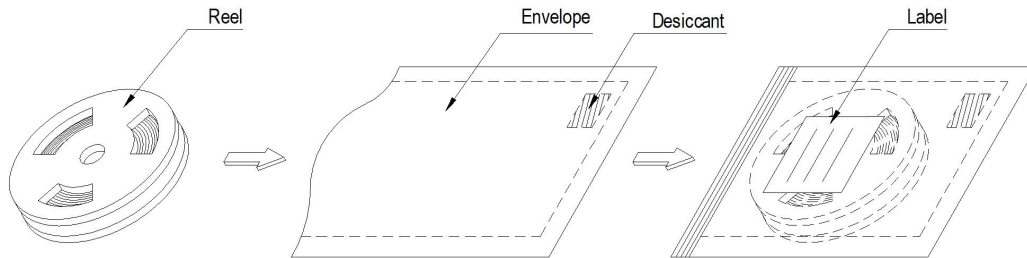

3. Label Form

	DIVISION VI LED Factory			
BOS-0603WDW				
SAP NO: 				
LOT NO: 				
VF(V): 				
IV(mcd): 				
CHC: 				
Q'ty(pcs) 				
Made in China			QA Date:	

Notes:

- SAP NO. :BYD Products Number
- Custom P/N:Custom Molde Number
- Q'TY: Packing Quantity
- IV: Luminous Intensity
- VF: Forward Voltage
- CHC: Coordinate rank



■ Reliability

1) Test Items and Results:

Classification	Test Item	Standard Test Method	Test Conditions	Duration	Units Tested	Number Of Damaged
Life Test	Operating Life Test	JIS7021:B4 MIL-STD-202:107D MIL-STD-750:1026	Ta=85°C±5°C,IF=20mA	1000 Hrs	22	0/22
Environment Test	High Temperature Storage	JIS7021:B10 MIL-STD-202:210A MIL-STD-750:2031	Ta=125°C±5°C	1000Hrs	22	0/22
	Low Temperature Storage	JIS7021:B12	Ta=-40°C±5°C	1000Hrs	22	0/22
	Temp. & Humidity Test	JIS7021:B11 MIL-STD-202:103D	Ta=85°C±5°C RH=85%±5%RH	1000Hrs	22	0/22
	Thermal Shock Test	JIS7021B4 MIL-STD-202:107D MIL-STD-750:1026	-40°C ← - → 125°C 15min 10sec 15min	1000 Cycles	22	0/22
	ESD	JESD22 A-114	±2KV	5 times	22	0/22
Soldering Test	Resistance to soldering		Tsol=260±5°C, 10sec	2 time	22	0/22

2) Criteria for Judge The Damage:

Items	Symbol	Condition	Criteria for Judge	
			Min.	Max.
Forward Voltage	V _F	I _F =20mA	---	initial value x 1.1
Reverse Current	I _R	V _R =5V	---	initial value x 1.1
Luminous Intensity	I _V	I _F =20mA	initial value x 0.8	---

■Precautions For Use

1. Over –current –proof

Customer must apply resistors for protection, otherwise slight voltage shift will cause big current change (Burn out will happen)

2. Storage Caution

2.1 The storage condition in sealed bags: at 5-35 °C and <70% relative humidity.

2.2 After bags are opened, the devices must be mounted within 168 hrs at <60% relative humidity.

2.3 It will be better to bake all devices before soldering.

2.4 Devices must be baked before mounting, if

A, the color of humidity indicator card at point “>30%” is pink (the original color is blue);

B, bags are opened over 168 hrs.

C. the stroge time (begin with QA date) is over 1 year.

2.5 The bake condition: 24 hrs at 65°C ± 5 °C (12-48 hrs will be available if 24 is not suitable)

3. Reflow Soldering / Time

3.1 Lead Solder/Time

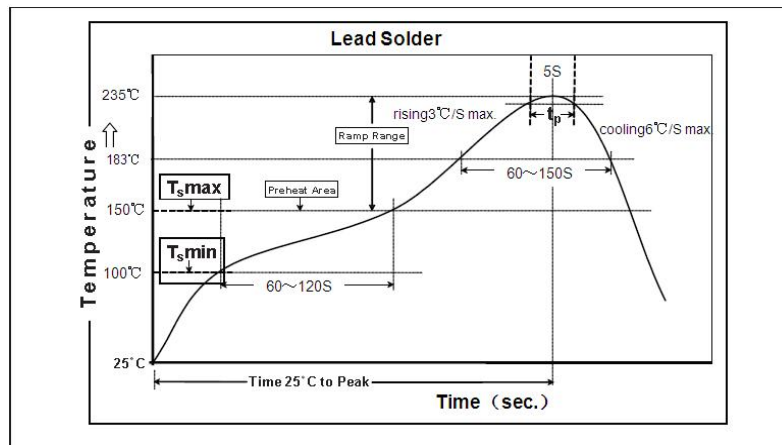

3.2 Lead-free Solder/Time

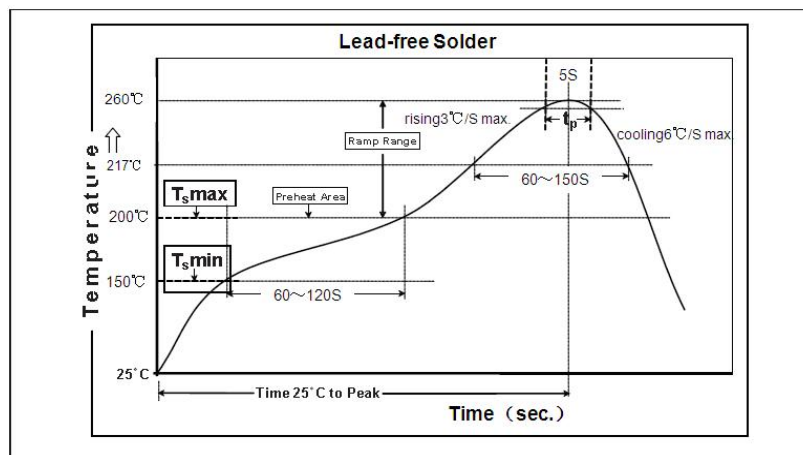

4. Soldering Iron

- 4.1 When hand soldering, keep the temperature of iron below less 300°C less than 3 seconds
- 4.2 The hand solder should be done only one times
- 4.3 The basic spec is ≤ 5 sec. when the temperature of 260°C, do not contact the resin when hand soldering

5. Rework

- 5.1. Customer must finish rework within 5 sec. under 260°C
- 5.2. The head of iron can not touch the resin
- 5.3. Twin-head type is preferred.

6. Control method of LED devices Usage

- 6.1. Before baking, it is necessary to fill in the baking form that including detail information such as model and lot number of devices, starting and ending time of baking, operators, etc. Devices that have longest dehumidify time should be used previously for those baked over 24 hrs. LED products that will not use immediately should be vacuum sealed when the baking time is almost 72hrs. Devices must be baked before next soldering.
- 6.2. The baked devices must be mounted within 168 hrs. After 168hrs, it needs to be re-baked before soldering.
- 6.3. The soldering interval should be less than 24hrs if the PCB with devices will be SMT for two times. PCB with devices must be baked 24 hrs at 65 ± 5 °C if the interval of two SMT is between 24hrs and 48hrs. Or PCB with devices must be baked 12 hrs at 100 °C to 125 °C if the interval of two SMT is between 24hrs and 48hrs.

7. Caution in ESD

- 7.1 Electrostatic discharge (ESD) and surge current (EOS) can damage LEDs.
- 7.2 An ESD wrist strap, ESD shoe strap or antistatic gloves must be worn whenever handling LEDs
- 7.3 All devices equipment and machinery must be properly grounded.

8. RESTRICTIONS ON PRODUCT USE

- The information contained herein is subject to change without notice.

- **BYD Semiconductor Company Limited** exerts the greatest possible effort to ensure high quality and reliability. Nevertheless, semiconductor devices in general can malfunction or fail due to their inherent electrical sensitivity and vulnerability to physical stress. It is the responsibility of the buyer, when utilizing products, to comply with the standards of safety in making a safe design for the entire system, including redundancy, fire-prevention measures, and malfunction prevention, to prevent any accidents, fires, or community damage that may ensue. In developing your designs, please ensure that products are used within specified operating ranges as set forth in the most recent products specifications.



- The products listed in this document are intended for usage in general electronics applications (computer, personal equipment, office equipment, measuring equipment, industrial robotics, domestic appliances, etc.). These products are neither intended nor warranted for usage in equipment that requires extraordinarily high quality and/or reliability or a malfunction or failure of which may cause loss of human life or bodily injury (“Unintended Usage”). Unintended Usage include atomic energy control instruments, airplane or spaceship instruments, transportation instruments, traffic signal instruments, combustion control instruments, medical instruments, all types of safety devices, etc.. Unintended Usage of products listed in this document shall be made at the customer’s own risk.