

## 概述/General Description

BG25F12M10S4 是一款由比亚迪半导体设计开发的 miniPACK 封装的三相全桥模块。该产品具有封装小、集成度高等优点；实现了三相变频电路的高度集成，能够紧凑地设计主电路。模块集成温度检测，可快速响应及温度实时输出。

BG25F12M10S4 is a cabinet and high integrated power module encapsulated by mini PACK that BYD has newly developed and designed. It highly combines convert circuit to make application circuit outside compact. It includes temperature detection function which can feedback quickly and output the analog temperature signal in real time.

## 产品特性/Features

- 1200V/25A,  $V_{CE\ sat}=2.0V@I_c=25A, 25^\circ C$
- 采用陶瓷覆铜板 (DBC), 低热阻设计  
Very low thermal resistance due to using DBC
- BYD 四代 IGBT 芯片技术, 低导通和开关损耗  
The 4<sup>th</sup> technology of BYD IGBT chip, low conduction and switching losses
- 饱和电压正温度系数  
Positive temperature coefficient
- 10 $\mu s$  短路耐受能力  
Short Circuit withstand time-10 $\mu s$

## 典型应用/Typical Applications

- 空调等变频家电  
Home appliances applications like air condition
- 变频、伺服控制器  
Convert and servo controller
- 三相电机逆变器  
Three-phase inverter for ac motor

## 封装/Package

miniPACK1

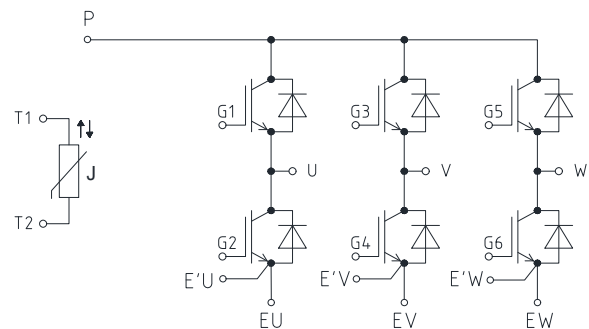
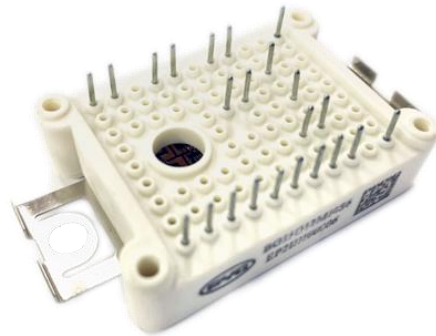



**IGBT,逆变器 / IGBT, Inverter**

**初步数据**

**Preliminary Data**

**最大额定值 / Maximum Rated Values**

( $T_J=25^{\circ}\text{C}$ ,除非另外注明/unless otherwise noted)

参数 Parameter	符号 Symbol	工作条件 Conditions	额定值 Ratings	单位 Units
集电极-发射极电压 Collector-emitter voltage	$V_{CES}$	$T_{vj} = 25^{\circ}\text{C}$	1200	V
连续集电极直流电流 Continuous DC collector current	$I_{c\ nom}$ $I_c$	$T_C = 100^{\circ}\text{C}, T_{vj\ max} = 175^{\circ}\text{C}$ $T_C = 25^{\circ}\text{C}, T_{vj\ max} = 175^{\circ}\text{C}$	25 45	A
集电极重复峰值电流 Repetitive peak collector current	$I_{CRM}$	$t_p = 1\ ms$	50	A
集电极功耗 Collector power dissipation	$P_{tot}$	$T_C = 50^{\circ}\text{C}, T_{vj\ max} = 175^{\circ}\text{C}$	208	W
栅极-发射极电压 Gate-emitter voltage	$V_{GES}$		$\pm 20$	V

**电气特性 / Electrical Characteristics**

参数 Parameter	符号 Symbol	工作条件 Conditions	最小值 Min.	典型值 Typ.	最大值 Max.	单位 Units	
集电极-发射极饱和电压 Collector-emitter saturation voltage	$V_{CEsat}$	$V_{GE}=15\text{V}, I_c=25\text{A}, T_{vj} = 25^{\circ}\text{C}$	1.7	1.9	2.0	V	
		$V_{GE}=15\text{V}, I_c=25\text{A}, T_{vj} = 150^{\circ}\text{C}$	-	2.5	-	V	
栅极-发射极阈值电压 Gate-emitter threshold voltage	$V_{GEth}$	$I_c=1\text{mA}, V_{GE}=V_{CE}, T_{vj}= 25^{\circ}\text{C}$	5.0	5.8	7.0	V	
栅极电荷 Gate charge	$Q_G$	$V_{GE} = -15\text{ V} \dots +15\text{ V}$		0.25		$\mu\text{C}$	
内部栅极电阻 Internal gate resistor	$R_{Gint}$	$T_{vj} = 25^{\circ}\text{C}$		12		$\Omega$	
输入电容 Input capacitance	$C_{ies}$	$f = 1\text{ MHz}, T_{vj} = 25^{\circ}\text{C}, V_{CE} = 25\text{ V}, V_{GE} = 0\text{ V}$		2		nF	
反向传输电容 Reverse transfer capacitance	$C_{res}$	$f = 1\text{ MHz}, T_{vj} = 25^{\circ}\text{C}, V_{CE} = 25\text{ V}, V_{GE} = 0\text{ V}$		0.08		nF	
集电极-发射极截止电流 Collector-emitter cut-off current	$I_{CES}$	$V_{CE}=1200\text{V}, V_{GE}=0\text{V}, T_{vj}= 25^{\circ}\text{C}$	-	-	0.1	mA	
栅极发射极漏电流 Gate leakage current	$I_{GES}$	$V_{CE}=0\text{V}, V_{GE}=\pm 20\text{V}, T_{vj}= 25^{\circ}\text{C}$	-	-	200	nA	
开通延迟时间 Turn-on delay time	$T_{don}$	$V_{CC}=600\text{V}, I_c=25\text{A}, V_{GE}=\pm 15\text{V}, R_G=20\Omega$	$T_{vj}=25^{\circ}\text{C}$	-	56.7	-	ns
			$T_{vj}=150^{\circ}\text{C}$	-	57.6	-	
上升时间 Rise time	$t_r$		$T_{vj}=25^{\circ}\text{C}$	-	60.3	-	
			$T_{vj}=150^{\circ}\text{C}$	-	64.3	-	
开通损耗 Turn-on energy loss	$E_{on}$		$T_{vj}=25^{\circ}\text{C}$	-	2.6	-	mJ
			$T_{vj}=150^{\circ}\text{C}$	-	3.9	-	
关断延迟时间 Turn-off delay time	$T_{doff}$		$T_{vj}=25^{\circ}\text{C}$	-	159.4	-	ns
			$T_{vj}=150^{\circ}\text{C}$	-	197.1	-	



下降时间 Fall time	$t_f$		$T_{vj} = 25^\circ\text{C}$	-	15.9	-	
			$T_{vj} = 150^\circ\text{C}$	-	246.3	-	
关断损耗 Turn-off energy loss	$E_{off}$		$T_{vj} = 25^\circ\text{C}$	-	1.18	-	mJ
			$T_{vj} = 150^\circ\text{C}$	-	1.84	-	
短路耐受时间 Short-circuited withstand time	$t_{sc}$	$V_{CC} = 800\text{V}, V_{CE} \leq 1200\text{V}, V_{GE} \leq 15\text{V}, T_j \leq 150^\circ\text{C}$	10	-	-	-	$\mu\text{s}$
反偏安全工作区 Reverse biased safe operating area	RBSOA	$V_{CC} = 800\text{V}, V_{CE} \leq 1200\text{V}, V_{GE} = 20\text{V}, T_j \leq 150^\circ\text{C}$	50	-	-	-	A
结-外壳热阻 Thermal resistance, junction to case	$R_{thJC}$	每个 IGBT / per IGBT	-	1.13	-	-	K/W
在开关状态下温度 Temperature under switching conditions	$T_{vj op}$		-40	-	150	-	$^\circ\text{C}$

## 二极管, 逆变器 / Diode, Inverter

### 最大额定值 / Maximum Rated Values

( $T_j = 25^\circ\text{C}$ , 除非另外注明/unless otherwise noted)

参数 Parameter	符号 Symbol	工作条件 Conditions	额定值 Ratings	单位 Units
反向重复峰值电压 Repetitive peak reverse voltage	$V_{RRM}$	$V_{GE} = 0\text{V}, I_C = 25\text{A}$	1200	V
连续正向直流电流 Continuous Forward current	$I_F$		25	A
正向重复峰值电流 Repetitive peak forward current	$I_{FRM}$	持续 1ms 的脉冲宽度 less than 1ms	50	A
$I^2t$ -值 $I^2t$ - value	$I^2t$	$V_R = 0\text{V}, t_P = 10\text{ms}, T_{vj} = 150^\circ\text{C}$	244	$\text{A}^2\text{S}$



电气特性 / Electrical Characteristics

参数 Parameter	符号 Symbol	工作条件 Conditions	最小值 Min.	典型值 Typ.	最大值 Max.	单位 Units	
正向压降 Forward voltage	V <sub>F</sub>	I <sub>F</sub> =25A	T <sub>vj</sub> =25°C	-	1.9	2.3	V
			T <sub>vj</sub> =150°C	-	1.87	-	V
反向恢复峰值电流 Peak reverse recovery current	I <sub>RM</sub>	T <sub>vj</sub> =25°C	-	9.7	-	A	
		T <sub>vj</sub> =150°C	-	13.4	-	A	
反向恢复电荷 Recovered charge	Q <sub>r</sub>	T <sub>vj</sub> =25°C	-	1.97	-	μC	
		T <sub>vj</sub> =150°C	-	4.84	-	μC	
反向恢复损耗 Reverse recovery energy	E <sub>rec</sub>	T <sub>vj</sub> =25°C	-	0.745	-	mJ	
		T <sub>vj</sub> =150°C	-	1.946	-	mJ	
结-外壳热阻 Thermal resistance, junction to case	R <sub>thJC</sub>	每个二极管 / per diode	-	1.55	-	K/W	
在开关状态下温度 Temperature under switching conditions	T <sub>vj op</sub>		-40	-	150	°C	

负温度系数热敏电阻 / NTC-Thermistor

电气特性 / Electrical Characteristics

参数 Parameter	符号 Symbol	工作条件 Conditions	最小值 Min.	典型值 Typ.	最大值 Max.	单位 Units
额定电阻值 Rated resistance	R <sub>25</sub>	T <sub>vj</sub> = 25°C	-	5	-	kΩ
R100 偏差 Deviation of R100	ΔR/R	T <sub>vj</sub> = 100°C, R100 = 465Ω	-7.2	-	7.5	%
耗散功率 Power dissipation	P <sub>25</sub>	T <sub>vj</sub> = 25°C	2	-	-	mW
B-值 B-value	B <sub>25/50</sub>	$R_2 = R_{25} \exp [B_{25/50}(1/T_2 - 1/(298,15 K))]$	-	3380	-	K



**模块 / Module**

参数 Parameter	符号 Symbol	工作条件 Conditions	典型值 Typ.	单位 Units
绝缘耐压 Isolation test voltage	$V_{ISOL}$	RMS, f = 50 Hz, t = 1 min.	2.5	kV
内部绝缘介质 Internal isolation		基本绝缘 (class 1, IEC 61140) basic insulation (class 1, IEC 61140)	$Al_2O_3$	
爬电距离 Creepage distance		端子 - 散热片 /Terminal to heatsink	11.5	mm
		端子 - 端子 /Terminal to terminal	6.3	mm
电气间隙 Clearance		端子 - 散热片 /Terminal to heatsink	10	mm
		端子 - 端子 /Terminal to terminal	5	mm

参数 Parameter	符号 Symbol	工作条件 Conditions	最小值 Min.	典型值 Typ.	最大值 Max.	单位 Units	
杂散电感 Stray inductance	$L_{sCE}$		-	20.0	-	nH	
模块引线电阻,端子-芯片 Module lead resistance, terminals - chip	$T_{jop}$	$T_C = 25^\circ C$ , 每个开关 /per switch	$R_{CC'+EE'}$	-	5.0	-	m $\Omega$
			$R_{AA'+CC'}$	-	6.0	-	m $\Omega$
储存温度 Storage temperature	$T_{stg}$		-40	-	125	$^\circ C$	
模块的安装扭矩 Mounting torque for module mounting	M	M4 螺栓 Screw M4	2.0	-	3.5	N.m	
重量 Weight	G		-	24	-	g	

输出特性 IGBT, 逆变器 (典型)  
output characteristic IGBT, Inverter  
(typical)

$I_C = f(V_{CE})$   
 $V_{GE} = 15V$

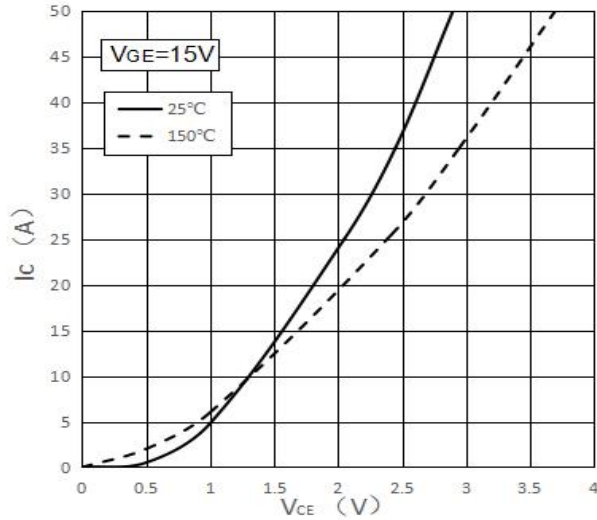

输出特性 IGBT, 逆变器 (典型)  
output characteristic IGBT, Inverter  
(typical)

$I_C = f(V_{CE})$   
 $T_{vj} = 150^\circ C$

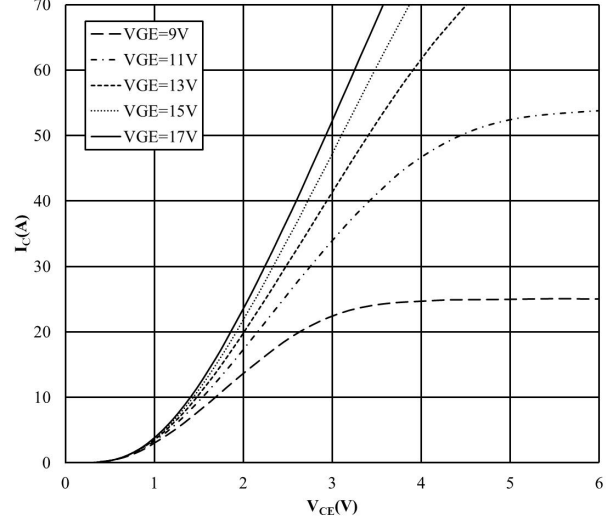

传输特性 IGBT, 逆变器 (典型)  
transfer characteristic IGBT, Inverter  
(typical)

$I_C = f(V_{GE})$   
 $V_{CE} = 20V$

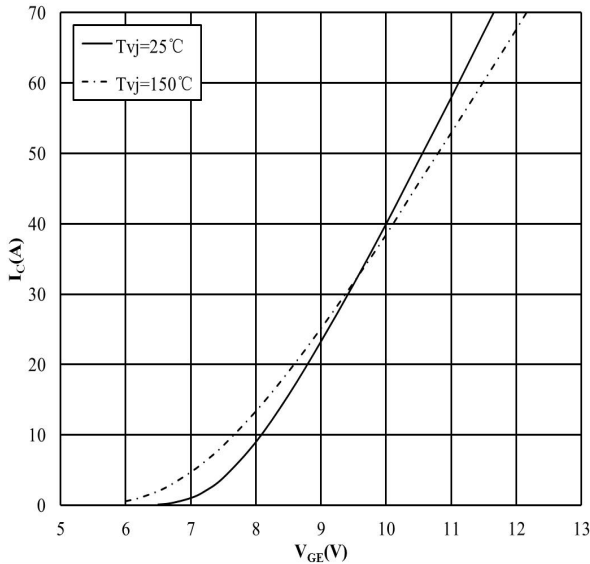

开关损耗 IGBT, 逆变器 (典型)  
switching losses IGBT, Inverter (typical)

$E_{on} = f(I_C), E_{off} = f(I_C)$   
 $V_{GE} = \pm 15V, R_{Gon} = 20\Omega, R_{Goff} = 20\Omega,$   
 $V_{CE} = 600V$

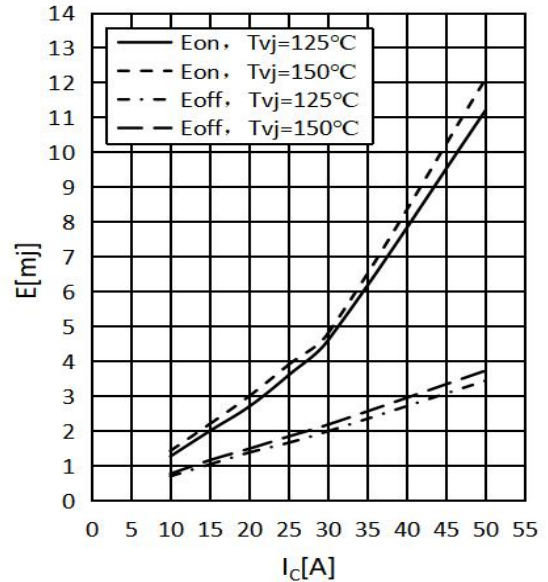

开关损耗 IGBT, 逆变器 (典型)  
switching losses IGBT, Inverter (typical)

$E_{on} = f(R_G)$ ,  $E_{off} = f(R_G)$   
 $V_{GE} = \pm 15 V$ ,  $I_C = 25A$ ,  $V_{CE} = 600V$

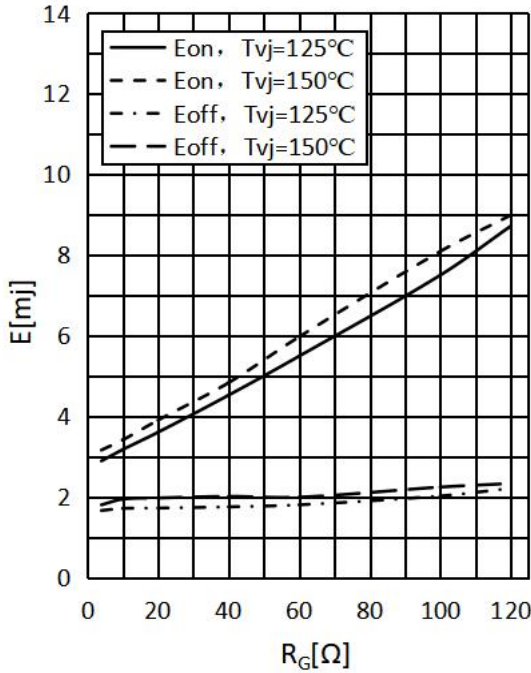

反偏安全工作区 IGBT, 逆变器 (RBSOA)  
reverse bias safe operating area IGBT,  
Inverter (RBSOA)

$I_C = f(V_{CE})$   
 $V_{GE} = \pm 15 V$ ,  $R_{Goff} = 12\Omega$ ,  $T_{vj} = 150^\circ C$

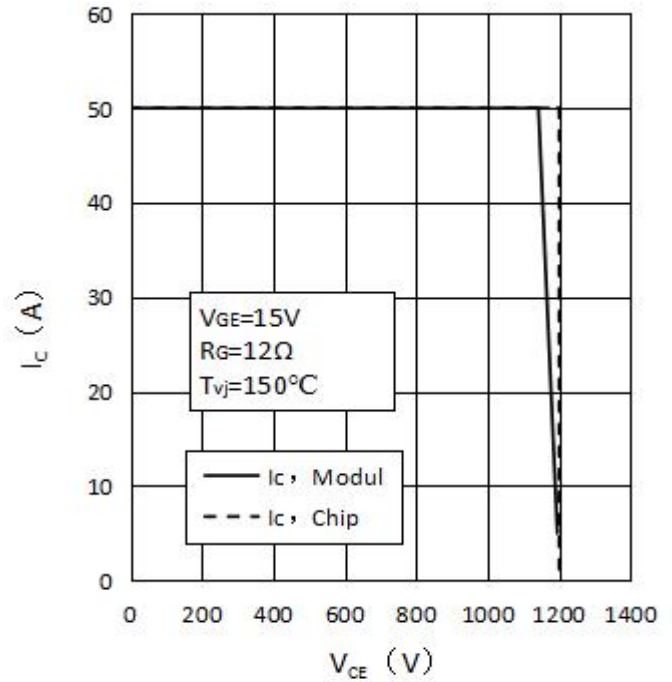

正向偏压特性 二极管, 逆变器 (典型)  
forward characteristic of Diode, Inverter  
(typical)

$I_F = f(V_F)$

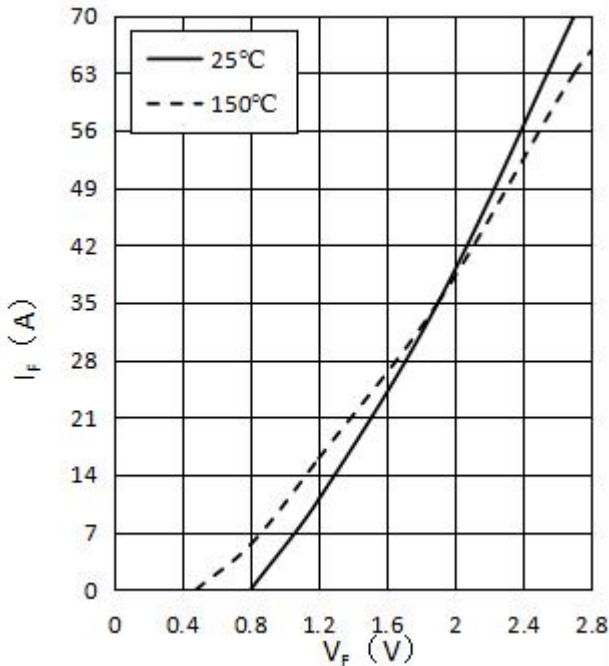

开关损耗 二极管, 逆变器 (典型)  
switching losses Diode, Inverter (typical)

$E_{rec} = f(I_F)$   
 $R_{Gon} = 20\Omega$ ,  $V_{CE} = 600V$

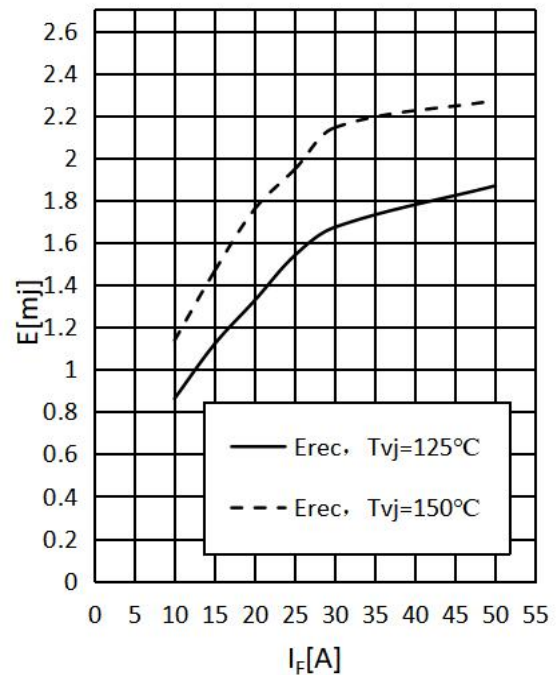

开关损耗 二极管,逆变器 (典型)  
**switching losses Diode, Inverter (typical)**

$E_{rec} = f(R_G)$   
 $I_F = 25A, V_{CE} = 600V$

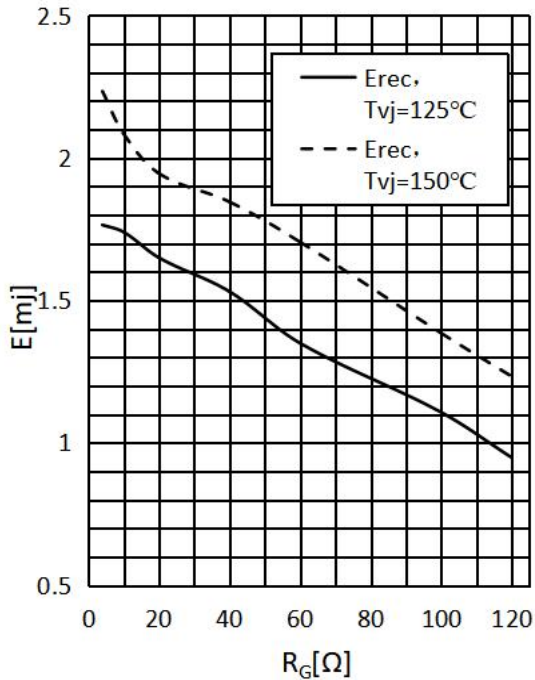

瞬态热阻抗 二极管,逆变器  
**transient thermal impedance Diode, Inverter**

$Z_{thJH} = f(t)$

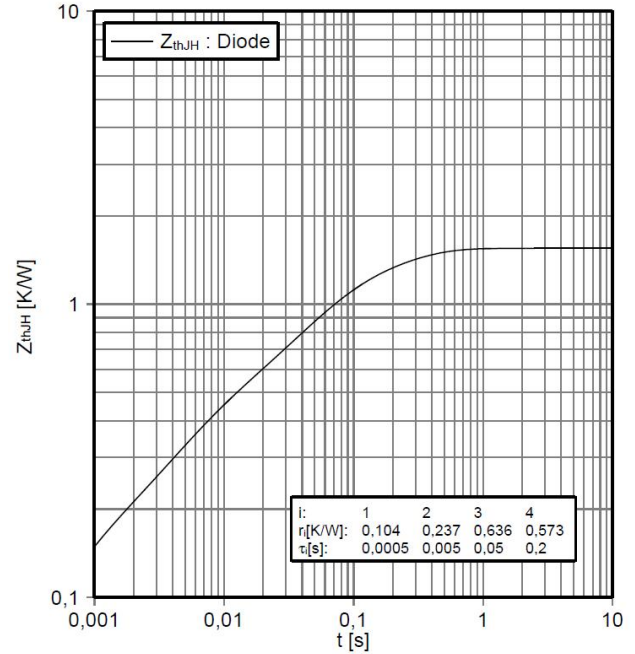

瞬态热阻抗 IGBT, 逆变器  
**transient thermal impedance IGBT, Inverter**

$Z_{thJH} = f(t)$

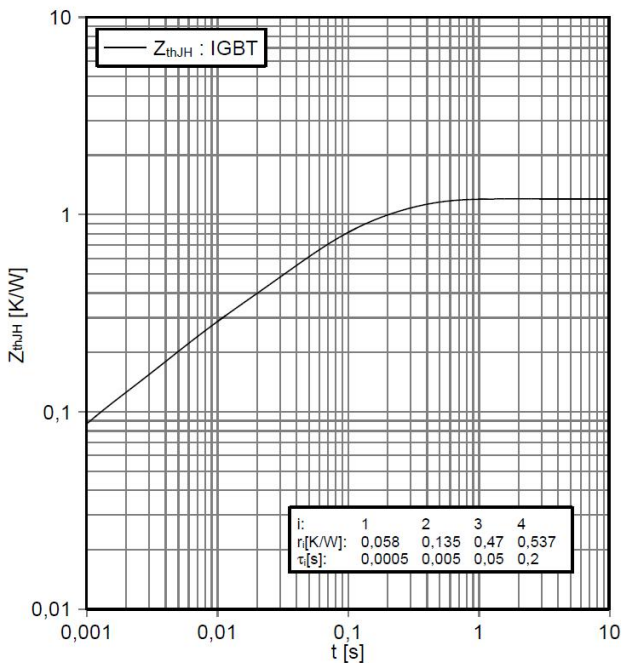

负温度系数热敏电阻 温度特性  
**NTC-Thermistor-temperature characteristic (typical)**

$R = f(T)$

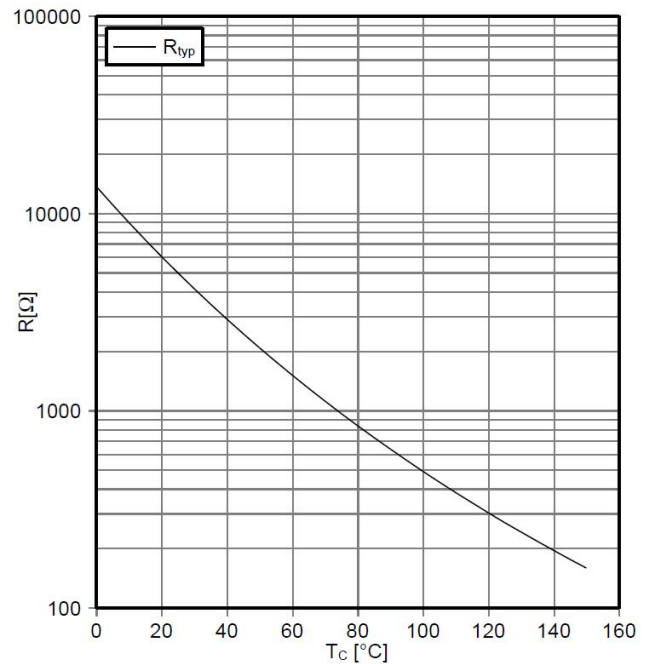







## 产品使用限制

- 本协议所包含的信息如有更改，恕不另行通知。
- 比亚迪半导体股份有限公司(简称 BYD)致力于产品的高性能和高可靠性。然而，半导体器件一般会因为其固有的对电荷敏感性和易受物理应力损坏的特点，而发生故障和失效。当用户购买 BYD 的产品时，用户有责任按照安全标准来为整个系统做出安全的设计来防止任何事故，火灾或继而引起的危害公共安全，包括设计的冗余，防火措施，故障预防。请改善您的设计，确保 BYD 的产品在额定范围内使用并参考最新的 BYD 产品规格书。
- 本文件中所列的产品拟用于一般电子产品的应用（计算机、个人设备、办公设备、测量设备、工业机器人技术、家用电器等）。这些产品既不打算也不保证使用在需要非常高质量和/或可靠性或故障或可能导致人员生命损失或人身伤害（“意外使用”）的故障的设备。意外的用途包括原子能控制仪器，飞机或宇宙飞船仪器，运输仪表，交通信号仪表，燃烧控制仪表，医疗仪表，所有安全装置的类型等。本文件中所列产品的意外使用，应归在客户自己的风险。