

## Preliminary datasheet

### 概述/General Description

This IGBT module adopts I-type NPC three level compatible package, which is suitable for Solar inverter and UPS. The integrated field stop IGBT and fast recovery diode provide lower conduction losses and switching losses, enabling designers to achieve high efficiency and superior reliability.

这款 IGBT 模块采用 I 型 NPC 三电平兼容封装，适用于光伏逆变器和 UPS 等。模块采用低导通损耗和低开关损耗的场终止 IGBT 和快恢复二极管芯片，使设计师能够实现高效率和卓越的可靠性。

### 产品特性/Features

- 三电平应用  
3-Level-Applications
- 低杂散电感设计  
Low inductive design
- 兼容封装  
Compatible package

### 典型应用/Typical Applications

- 光伏应用  
Solar Applications
- UPS  
UPS systems

### 封装/Package

miniNPC2

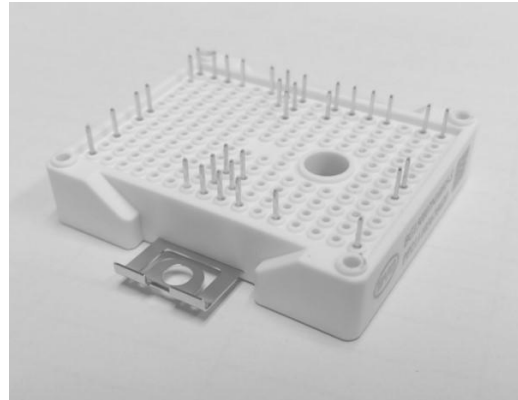

### 拓扑图/Schematic

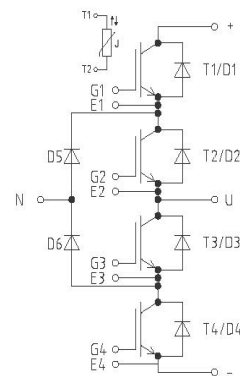



IGBT,逆变器 / IGBT, Inverter

初步数据

最大额定值 / Maximum Rated Values

Preliminary Data

(T<sub>J</sub>=25°C,除非另外注明/unless otherwise noted)

参数 Parameter	符号 Symbol	工作条件 Conditions	额定值 Ratings	单位 Units
集电极-发射极电压 Collector-emitter voltage	V <sub>CEs</sub>	T <sub>vj</sub> = 25°C	650	V
连续集电极直流电流 Continuous DC collector current	I <sub>C nom</sub>	T <sub>C</sub> = 25°C, T <sub>vj</sub> max = 175°C	100	A
集电极重复峰值电流 Repetitive peak collector current	I <sub>CRM</sub>	t <sub>p</sub> = 1 ms	200	A
功耗 Total power dissipation	P <sub>tot</sub>	T <sub>C</sub> = 25°C, T <sub>vj</sub> = 175°C	365	W
栅极-发射极峰值电压 Gate-emitter peak voltage	V <sub>GES</sub>		±20	V

电气特性 / Electrical Characteristics

参数 Parameter	符号 Symbol	工作条件 Conditions	最小值 Min.	典型值 Typ.	最大值 Max.	单位 Units
集电极-发射极饱和电压 Collector-emitter saturation voltage	V <sub>CEsat</sub>	V <sub>GE</sub> =15V, I <sub>C</sub> =100A, T <sub>vj</sub> = 25°C	-	1.8	2.2	V
		V <sub>GE</sub> =15V, I <sub>C</sub> =100A, T <sub>vj</sub> = 150°C	-	2.1	-	V
栅极-发射极阈值电压 Gate-emitter threshold voltage	V <sub>GEth</sub>	I <sub>C</sub> =2.4mA, V <sub>GE</sub> =V <sub>CE</sub> , T <sub>vj</sub> = 25°C	5.0	6.0	7.0	V
栅极电荷 Gate charge	Q <sub>G</sub>	V <sub>GE</sub> = -15 V ... +15 V	-	0.48	-	μC
内部栅极电阻 Internal gate resistor	R <sub>Gint</sub>	T <sub>vj</sub> = 25°C	-	2.5	-	Ω
输入电容 Input capacitance	C <sub>ies</sub>	f = 1 MHz, T <sub>vj</sub> = 25°C, V <sub>CE</sub> = 25 V, V <sub>GE</sub> = 0 V	-	10.04	-	nF
输出电容 Output capacitance	C <sub>oss</sub>	f = 1 MHz, T <sub>vj</sub> = 25°C, V <sub>CE</sub> = 25 V, V <sub>GE</sub> = 0 V	-	0.46	-	nF
反向传输电容 Reverse transfer capacitance	C <sub>res</sub>	f = 1 MHz, T <sub>vj</sub> = 25°C, V <sub>CE</sub> = 25 V, V <sub>GE</sub> = 0 V	-	0.32	-	nF
集电极-发射极截止电流 Collector-emitter cut-off current	I <sub>CES</sub>	V <sub>CE</sub> =650V, V <sub>GE</sub> =0V, T <sub>vj</sub> = 25°C	-	-	0.2	mA
栅极发射极漏电流 Gate-emitter leakage current	I <sub>GES</sub>	V <sub>CE</sub> =0V, V <sub>GE</sub> =±20V, T <sub>vj</sub> = 25°C	-	-	200	nA



开通延迟时间 Turn-on delay time	$t_{d\ on}$	$V_{CC}=300V,$ $I_C=100A,$ $V_{GE}=\pm 15V,$ $R_G=10\Omega$	$T_{vj}=25^\circ C$	-	100	-	ns
			$T_{vj}=150^\circ C$	-	120	-	
上升时间 Rise time	$t_r$		$T_{vj}=25^\circ C$	-	80	-	ns
			$T_{vj}=150^\circ C$	-	90	-	
开通损耗 Turn-on energy loss	$E_{on}$		$T_{vj}=25^\circ C$	-	1.5	-	mJ
			$T_{vj}=150^\circ C$	-	2.1	-	
关断延迟时间 Turn-off delay time	$t_{d\ off}$		$T_{vj}=25^\circ C$	-	230	-	ns
			$T_{vj}=150^\circ C$	-	270	-	
下降时间 Fall time	$t_f$		$T_{vj}=25^\circ C$	-	50	-	ns
			$T_{vj}=150^\circ C$	-	130	-	
关断损耗 Turn-off energy loss	$E_{off}$		$T_{vj}=25^\circ C$	-	0.9	-	mJ
			$T_{vj}=150^\circ C$	-	1.2	-	
短路耐受时间 Short-circuited withstand time	$t_{sc}$		$V_{CC} = 360V, V_{CE} \leq 650V,$ $V_{GE} \leq 15V, T_j \leq 150^\circ C$	8	-	-	$\mu s$
结-外壳热阻 Thermal resistance, junction to case	$R_{thJC}$		每个 IGBT / per IGBT	-	0.41	-	K/W
外壳-散热器热阻 Thermal resistance, case to heatsink	$R_{thCH}$	每个 IGBT / per IGBT $\lambda_{Paste} = 1\ W/(m\cdot K) / \lambda_{grease} = 1\ W/(m\cdot K)$	-	0.52	-	K/W	
开关状态下温度 Temperature under switching conditions	$T_{vj\ op}$		-40	-	150	$^\circ C$	



## 二极管,D1-D6 / Diode, D1-D6

### 最大额定值 / Maximum Rated Values

( $T_J=25^{\circ}\text{C}$ ,除非另外注明/unless otherwise noted)

参数 Parameter	符号 Symbol	工作条件 Conditions	额定值 Ratings	单位 Units
反向重复峰值电压 Repetitive peak reverse voltage	$V_{RRM}$	$V_{GE}=0\text{V}$ , $I_C=100\text{A}$	650	V
连续正向直流电流 Continuous DC forward current	$I_F$		100	A
正向重复峰值电流 Repetitive peak forward current	$I_{FRM}$	$t_P=1\text{ms}$	200	A
$I^2t$ -值 $I^2t$ - value	$I^2t$	$V_R = 0\text{V}$ , $t_P = 10\text{ms}$ , $T_{vj} = 150^{\circ}\text{C}$	900	$\text{A}^2\text{S}$

### 电气特性 / Electrical Characteristics

参数 Parameter	符号 Symbol	工作条件 Conditions	最小值	典型值	最大值	单位 Units	
			Min.	Typ.	Max.		
正向压降 Forward voltage	$V_F$	$I_F=100\text{A}$	$T_{vj}=25^{\circ}\text{C}$	1.2	1.45	1.9	V
			$T_{vj}=150^{\circ}\text{C}$	-	1.15	-	V
反向恢复峰值电流 Peak reverse recovery current	$I_{RM}$		$T_{vj}=25^{\circ}\text{C}$	-	60	-	A
			$T_{vj}=150^{\circ}\text{C}$	-	88	-	A
反向恢复电荷 Recovered charge	$Q_r$	$I_F=100\text{A}$ $V_R=300\text{V}$ $di/dt=1500\text{A}/\mu\text{s}$	$T_{vj}=25^{\circ}\text{C}$	-	3.6	-	$\mu\text{C}$
			$T_{vj}=150^{\circ}\text{C}$	-	8.6	-	$\mu\text{C}$
反向恢复损耗 Reverse recovery energy	$E_{rec}$		$T_{vj}=25^{\circ}\text{C}$	-	1.7	-	mJ
			$T_{vj}=150^{\circ}\text{C}$	-	2.2	-	mJ
结-外壳热阻 Thermal resistance, junction to case	$R_{thJC}$	每个二极管 / per diode	-	0.55	-	K/W	
外壳-散热器热阻 Thermal resistance, case to heatsink	$R_{thCH}$	每个二极管 / per diode $\lambda_{\text{paste}} = 1\text{W}/(\text{m}\cdot\text{K})$ / $\lambda_{\text{grease}} = 1\text{W}/(\text{m}\cdot\text{K})$	-	0.72	-	K/W	
开关状态下温度 Temperature under switching conditions	$T_{vj\text{op}}$		-40	-	150	$^{\circ}\text{C}$	



## 负温度系数热敏电阻 / NTC-Thermistor

### 电气特性 / Electrical Characteristics

参数 Parameter	符号 Symbol	工作条件 Conditions	最小值 Min.	典型值 Typ.	最大值 Max.	单位 Units
额定电阻值 Rated resistance	R <sub>25</sub>	T <sub>vj</sub> = 25°C	-	5	-	kΩ
R100 偏差 Deviation of R100	ΔR/R	T <sub>vj</sub> = 100°C, R100 = 465Ω	-7.3	-	7.5	%
耗散功率 Power dissipation	P <sub>25</sub>	T <sub>vj</sub> = 25°C	-	-	10	mW
B-值 B-value	B <sub>25/50</sub>	$R_2 = R_{25} \exp [B_{25/50}(1/T_2 - 1/(298,15 K))]$	-	3380	-	K

### 模块 / Module

参数 Parameter	符号 Symbol	工作条件 Conditions	典型值 Typ.	单位 Units
绝缘耐压 Isolation test voltage	V <sub>ISOL</sub>	RMS, f = 50 Hz, t = 1 min.	2.5	kV
内部绝缘介质 Internal isolation		基本绝缘 (class 1, IEC 61140) basic insulation (class 1, IEC 61140)	Al <sub>2</sub> O <sub>3</sub>	
爬电距离 Creepage distance		端子-散热片 Terminal to heatsink	11.5	mm
		端子-端子 Terminal to terminal	6.3	mm
电气间隙 Clearance		端子-散热片 Terminal to heatsink	10	mm
		端子-端子 Terminal to terminal	5	mm

参数 Parameter	符号 Symbol	工作条件 Conditions	最小值 Min.	典型值 Typ.	最大值 Max.	单位 Units
杂散电感 Stray inductance	L <sub>sCE</sub>		-	30	-	nH
模块引线电阻,端子-芯片 Module lead resistance, terminals - chip	R <sub>CC'+EE'</sub>	T <sub>C</sub> = 25°C, 每个开关/per switch	-	2	-	mΩ
储存温度 Storage temperature	T <sub>stg</sub>		-40	-	125	°C
每个夹具的安装力 Feder mountig force per clamp	F		40	-	80	N
重量 Weight	G		-	39	-	g



输出特性 IGBT, 逆变器 (典型)  
output characteristic IGBT, Inverter (typical)  
 $I_C = f(V_{CE})$   
 $V_{GE} = 15\text{ V}$

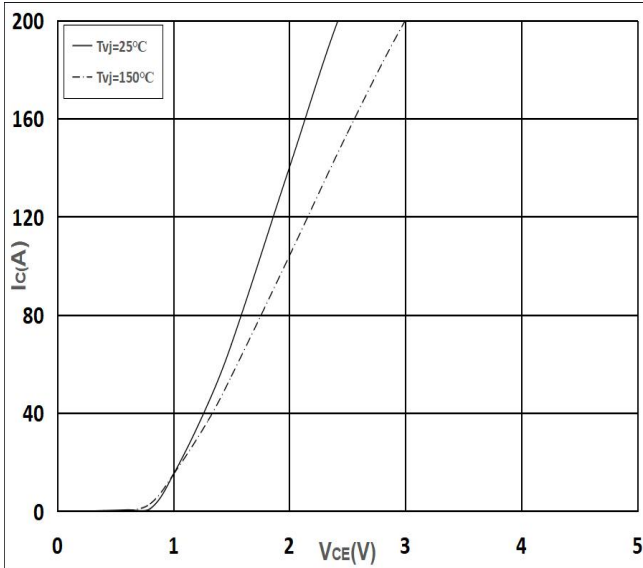

输出特性 IGBT, 逆变器 (典型)  
output characteristic IGBT, Inverter (typical)  
 $I_C = f(V_{CE})$   
 $T_{vj} = 150^\circ\text{C}$

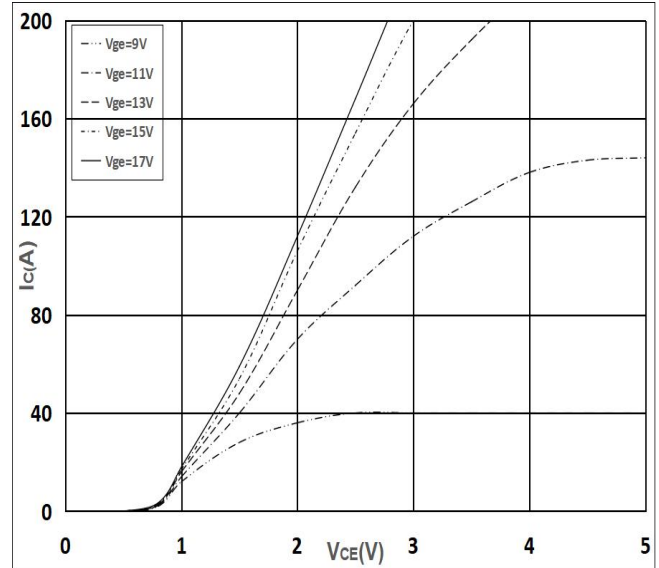

传输特性 IGBT, 逆变器 (典型)  
transfer characteristic IGBT, Inverter (typical)  
 $I_C = f(V_{GE})$   
 $V_{CE} = 20\text{ V}$

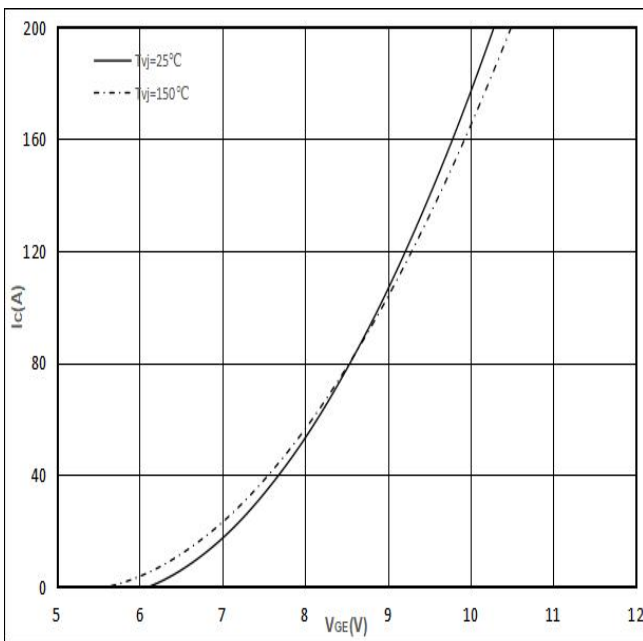

开关损耗 IGBT, 逆变器 (典型)  
switching losses IGBT, Inverter (typical)  
 $E_{on} = f(I_C)$ ,  $E_{off} = f(I_C)$   
 $V_{GE} = \pm 15\text{ V}$ ,  $R_{Gon} = 10\Omega$ ,  $R_{Goff} = 10\Omega$ ,  
 $V_{CE} = 300\text{ V}$ ,  $T_{vj} = 25^\circ\text{C}$

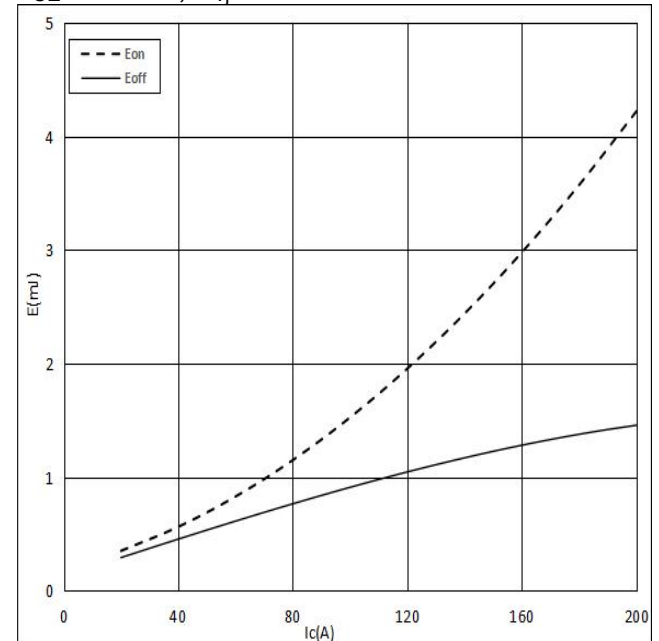



开关损耗 IGBT, 逆变器 (典型)  
switching losses IGBT, Inverter (typical)

$E_{on} = f(I_C), E_{off} = f(I_C)$   
 $V_{GE} = \pm 15V, R_{Gon} = 10\Omega, R_{Goff} = 10\Omega,$   
 $V_{CE} = 300V, T_{vj} = 150^\circ C$

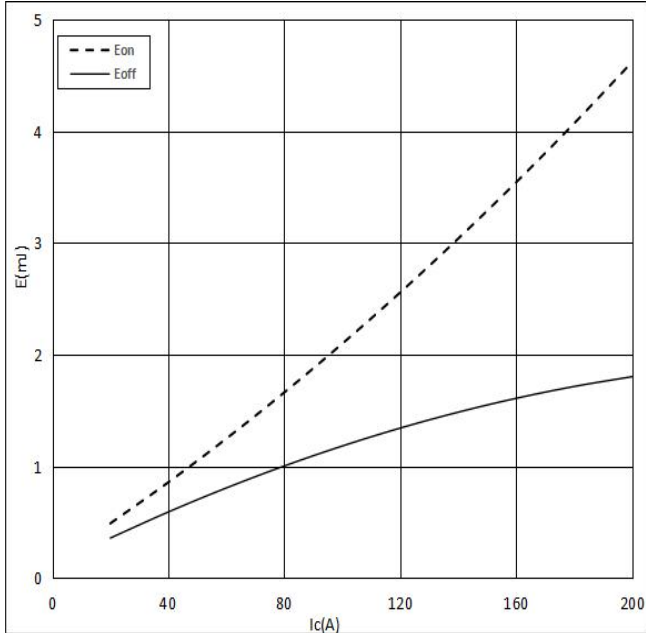

开关损耗 IGBT, 逆变器 (典型)  
switching losses IGBT, Inverter (typical)

$E_{on} = f(R_G), E_{off} = f(R_G)$   
 $V_{GE} = \pm 15V, I_C = 100A, V_{CE} = 300V,$   
 $T_{vj} = 25^\circ C$

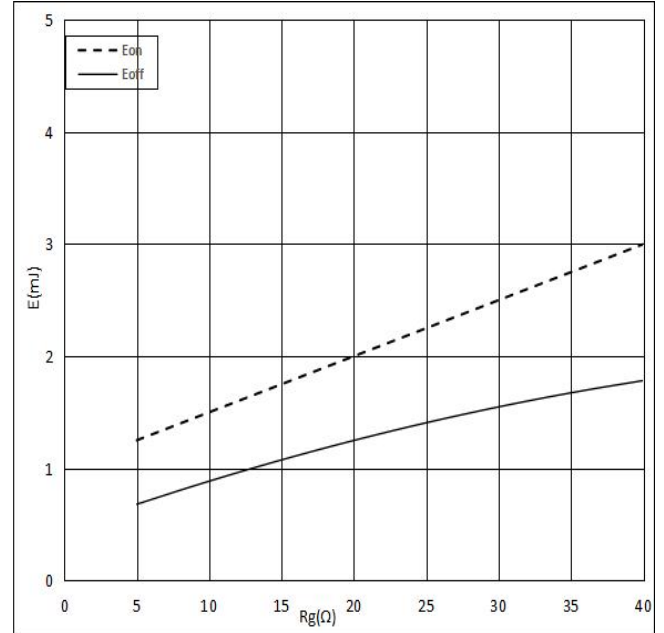

开关损耗 IGBT, 逆变器 (典型)  
switching losses IGBT, Inverter (typical)

$E_{on} = f(R_G), E_{off} = f(R_G)$   
 $V_{GE} = \pm 15V, I_C = 100A, V_{CE} = 300V,$   
 $T_{vj} = 150^\circ C$

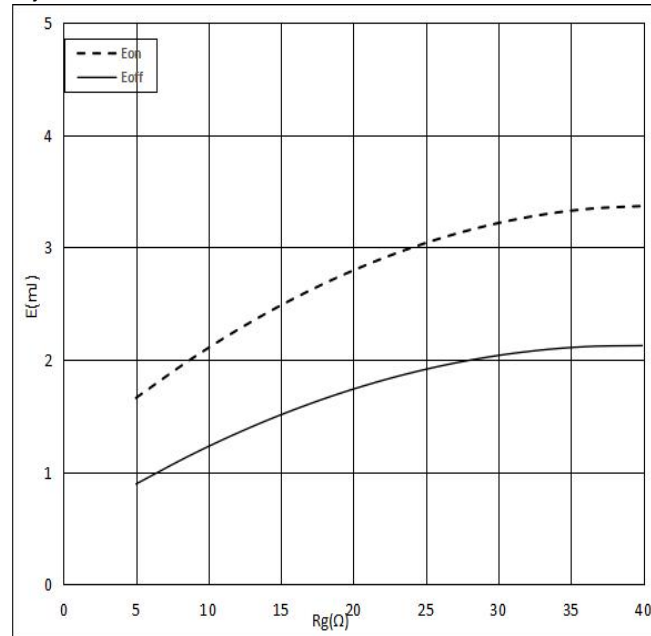

反偏安全工作区 IGBT, 逆变器 (RBSOA)  
reverse bias safe operating area IGBT,  
Inverter (RBSOA)

$I_C = f(V_{CE})$   
 $V_{GE} = \pm 15V, R_{Goff} = 10\Omega, T_{vj} = 150^\circ C$

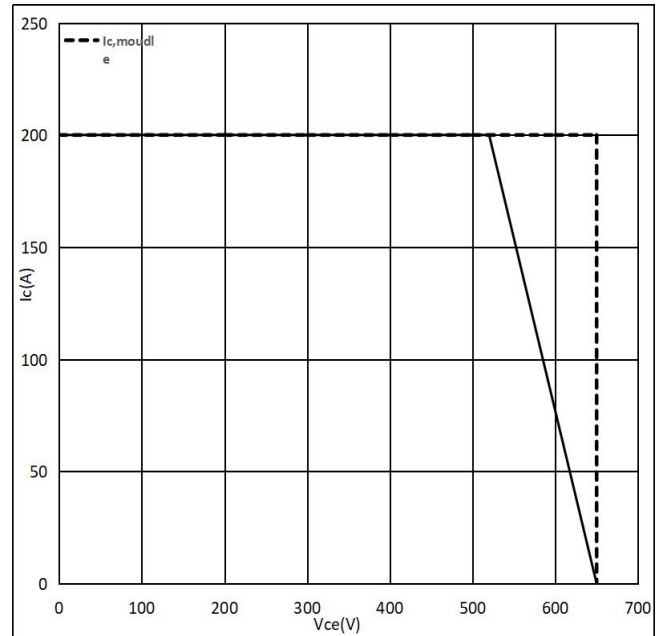

正向偏压特性 二极管,逆变器, D1-D6 (典型)  
**forward characteristic of Diode, Inverter (typical)**

$I_F = f(V_F)$

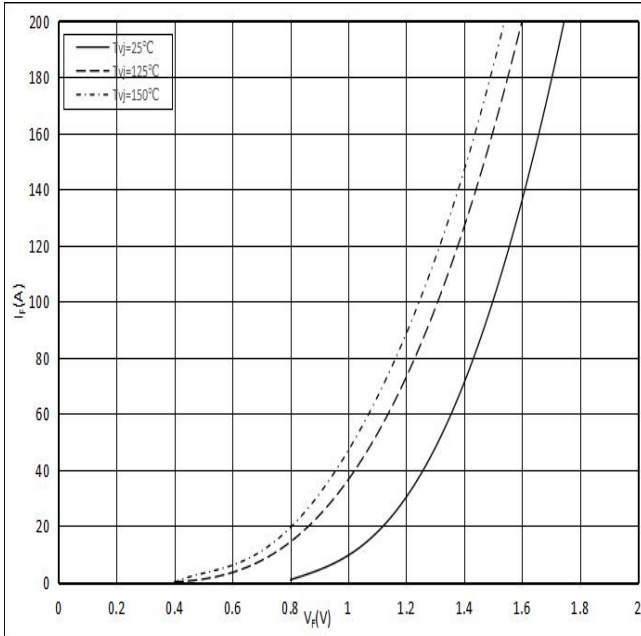

开关损耗 二极管,逆变器, D1-D6 (典型)  
**switching losses Diode, Inverter (typical)**

$E_{rec} = f(R_G)$

$I_F = 150A, V_{CE} = 300V$

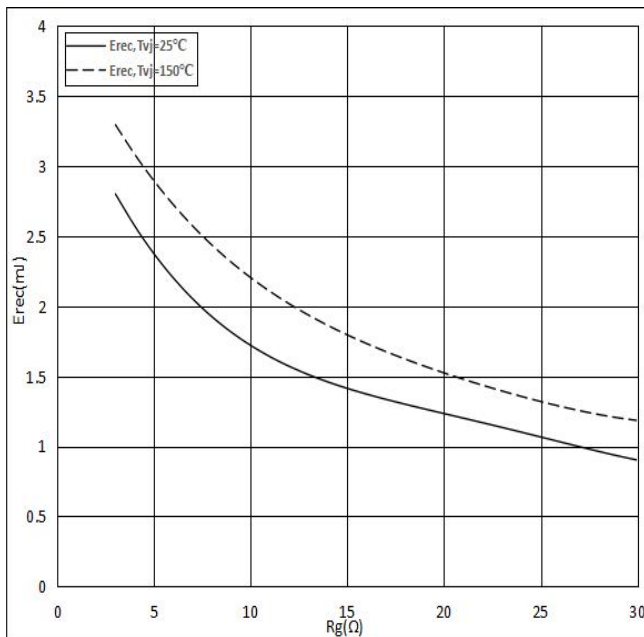

开关损耗 二极管,逆变器, D1-D6 (典型)  
**switching losses Diode, Inverter (typical)**

$E_{rec} = f(I_F)$

$R_G = 10\Omega, V_{CE} = 300V$

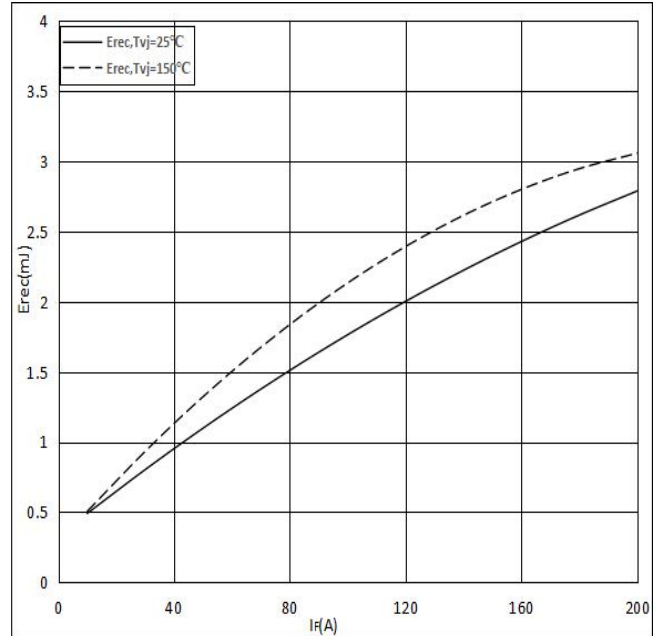

负温度系数热敏电阻 温度特性  
**NTC-Thermistor-temperature characteristic (typical)**

$R = f(T)$

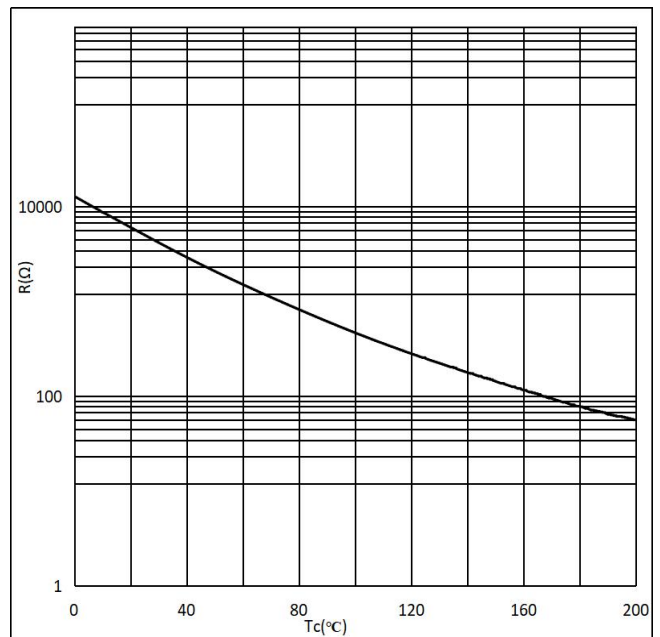



接线图 / circuit\_diagram\_headline

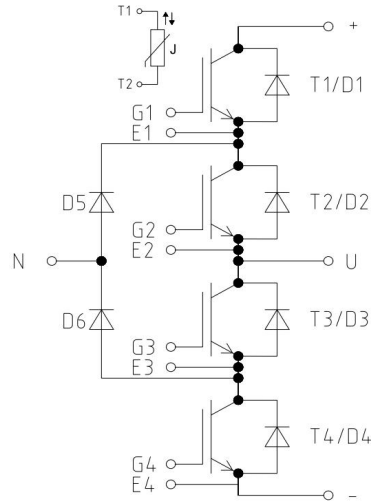

封装尺寸 / package outlines

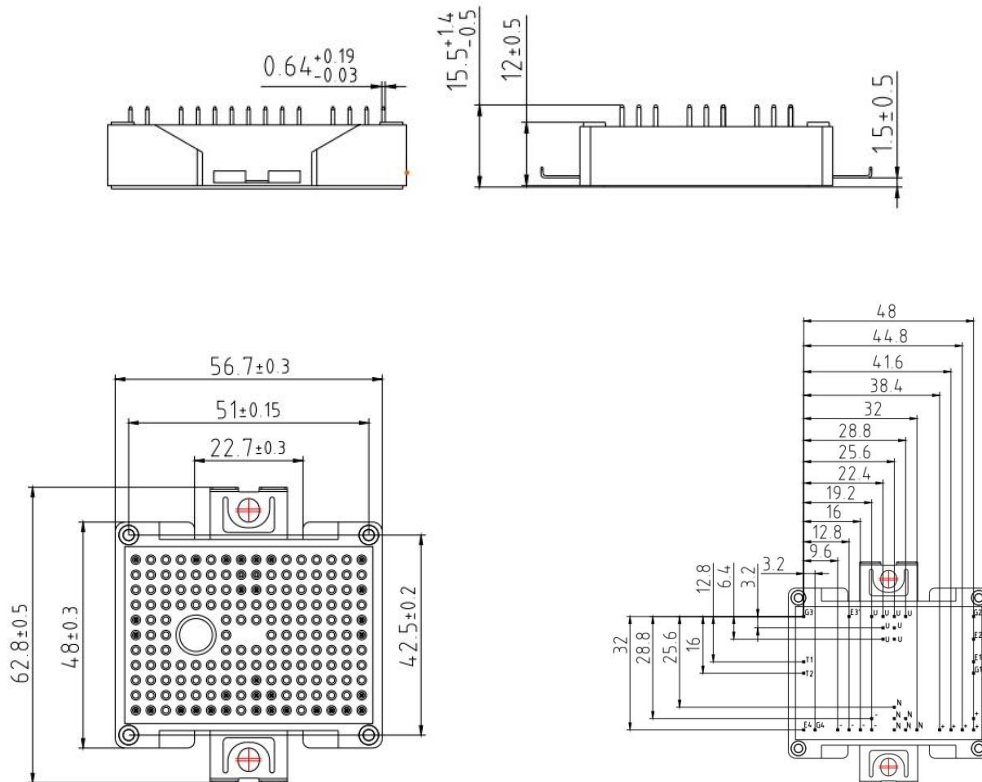

**☐ Attention****Correct and Safety Use of Power Module**

- Unsuitable operation (such as electrical, mechanical stress and so on) may lead to damage of power modules.

Please pay attention to the following descriptions and use BYD's IGBT modules according to the guidance.

**During Transit:**

- Tossing or dropping of a carton may damage devices inside.
- If a device gets wet with water, malfunctioning and failure may result. Special care should be taken during rain or snow to prevent the devices from getting wet.

**Storage:**

- The temperature and humidity of the storage place should be 5~35°C and 45~75% respectively. The performance and reliability of devices may be jeopardized if devices are stored in an environment far above or below the range indicated above.

**Prolonged Storage:**

- When storing devices more than one year, dehumidifying measures should be provided for the storage place. When using devices after a long period of storage, make sure to check the exterior of the devices is free from scratches, dirt, rust, and so on.

**Operating Environment:**

- Devices should not be exposed to water, organic solvents, corrosive gases, explosive gases, fine particles, or corrosive agents, since any of those can lead to a serious accident.

**Anti-electrostatic Measures:**

- Following precautions should be taken for gated devices to prevent static buildup which could damage the devices.

(1) Precautions against the device rupture caused by static electricity

Static electricity of human bodies and cartons and/or excessive voltage applied across the gate to emitter may damage and rupture devices. Sense-emitter and temperature-sensor are also vulnerable to excessive voltage. The basis of anti-electrostatic is suppression of build-up and quick dissipation of the charged electricity.

\* Containers that are susceptible to static electricity should not be used for transit or for storage.

\* Signal terminals to emitter should be always shorted with a carbon cloth or the like until right before a module is used. Never touch the signal terminals with bare hands.

\* Always ground the equipment and your body during installation (after removing a carbon cloth or the like. It is advisable to cover the workstation and its surrounding floor with conductive mats and ground them.

\* Use soldering irons with grounded tips.

BYD Semiconductor Co., Ltd. (short for BYD) exerts the greatest possible effort to ensure high quality and reliability. Nevertheless, semiconductor devices in general can malfunction or fail due to their inherent electrical sensitivity and vulnerability to physical stress. It is the responsibility of the buyer, when utilizing BYD products, to comply with the standards of safety in making a safe design for the entire system, including redundancy, fire-prevention measures, and malfunction prevention, to prevent any accidents, fires, or community damage that may ensue. In developing your designs, please ensure that BYD products are used within specified operating ranges as set forth in the most recent BYD products specifications.

## □ 警示

### 功率模块安全正确的使用方法：

• 不当的操作（如电应力、机械应力等）可能导致模块损毁。请注意以下介绍，并根据指导来使用使用比亚迪IGBT模块。

### 运输过程中：

- 包装箱颠簸或坠落可能导致内部器件损毁。
- 器件遇水受潮将导致故障失效。在雨雪天气尤其要注意保护器件防止淋湿。

### 贮存：

• 贮存地点温度与湿度应分别控制在5~35°C和45~75%。如果贮存环境远高于或低于指示的变化范围，将危害器件的性能与可靠性。

### 长期贮存：

• 当存储器件时间超过一年，贮存地点应当采取去湿措施。器件经过长期存放使用时，检查器件确保外观没有刮伤，灰尘，锈迹等。

### 应用环境：

• 器件不应当暴露在水，有机溶剂，腐蚀性气体、易燃易爆性气体，微尘，腐蚀性药剂中，上述任何一种情况都会导致严重事故。

### 防静电措施：

• 带栅极器件应采取以下预警来防止可以损毁器件的静电生成。

(1) 预防措施可以防止静电击穿器件。

\* 门极与发射极间产生的人体静电、包装箱静电和过电压将损毁或击穿器件。采样发射极和温度传感器同样容易受到过压损毁。防静电底板可以抑制电荷生成并快速耗散。

\* 不要用易受静电影响的容器运输或贮存器件。

\* 发射极信号端子应一直用碳纤维布或类似物短接直到模块使用前。任何情况下不要徒手碰触信号端子。

\* 安装过程中始终保持设备和你的身体接地(移除碳纤维布或类似物后)。用导电垫覆盖工作地点及周围地板并使其接地。

\* 使用接地的烙铁头。

比亚迪半导体股份有限公司(简称BYD)致力于产品的高性能和高可靠性。然而，半导体器件一般会因其固有的对电荷敏感性和易受物理应力损坏的特点，而发生故障和失效。当用户购买BYD的产品时，用户有责任按照安全标准来为整个系统做出安全的设计来防止任何事故，火灾或继而引起的危害公共安全，包括设计的冗余，防火措施，故障预防。请改善您的设计，确保BYD的产品在额定范围内使用并参考最新的BYD产品规格书。